

RUX



**THERMAL IMAGING  
MONOCULAR**

# **STRIDE SERIES**

User Manual V1.0



# WARNING

## PLEASE READ BEFORE USE

**EN**

- Inspect batteries for damage before charging. • Fully charge batteries before use. • Avoid pointing the device at the sun or high heat sources.
- Damage to the core sensor caused by improper handling is not covered under warranty.

**DE**

- Prüfen Sie die Batterien vor dem Laden auf Schäden. • Laden Sie die Batterien vor Gebrauch vollständig auf. • Vermeiden Sie es, das Gerät auf die Sonne oder Wärmequellen zu richten. • Schäden am Kernsensor aufgrund unsachgemäßer Handhabung sind nicht garantiert.

**IT**

- Ispezionare le batterie per eventuali danni prima di caricarle. • Caricare completamente le batterie prima dell'uso. • Evitare di puntare il dispositivo verso il sole o fonti di calore intense. • I danni al sensore centrale causati da manomissioni non sono coperti dalla garanzia.

**FR**

- Vérifiez les batteries pour détecter tout dommage avant de les charger.
- Chargez complètement les batteries avant utilisation. • Évitez de diriger l'appareil vers le soleil ou des sources de chaleur intenses. • Les dommages au capteur principal causés par une mauvaise manipulation ne sont pas couverts par la garantie.

**ES**

- Inspeccione las baterías en busca de daños antes de cargarlas. • Cargue completamente las baterías antes de usarlas. • Evite apuntar el dispositivo hacia el sol o fuentes de calor intensas. • Los daños al sensor principal causados por manipulación incorrecta no están cubiertos por la garantía.

**CZ**

- Před nabíjením zkontrolujte baterie na poškození. • Před použitím baterie úplně nabijte. • Vyhňte se zaměřování zařízení na slunce nebo zdroje vysokého tepla. • Poškození hlavního senzoru způsobené nesprávným zacházením není pokryto zárukou.

**PL**

- Przed ładowaniem sprawdź baterie pod kątem uszkodzeń. • W pełni naładuj baterie przed użyciem. • Unikaj celowania urządzeniem w słońce lub źródła silnego ciepła. • Uszkodzenia głównego czujnika spowodowane niewłaściwym użytkowaniem nie podlegają gwarancji.

**SV**

- Kontrollera batterierna för skador innan du laddar dem. • Ladda batterierna helt innan användning. • Undvik att rikta enheten mot solen eller starka värmekällor. • Skador på huvudsensorn orsakade av felaktig hantering omfattas inte av garantin.

**HU**

- Ellenőrizze a telepet sérülésre, mielőtt töltené. • Teljesen töltse fel a telepet használat előtt. • Ne irányítsa az eszközt a nap vagy nagy hőforrások felé. • A helytelen kezelésből eredő fő érzékelő károk nem tartoznak a garanciális fedezet alá.

**PT**

- Verifique as baterias quanto a danos antes de carregá-las. • Carregue completamente as baterias antes do uso. • Evite apontar o dispositivo para o sol ou fontes de calor intensas. • Danos ao sensor principal causados por manuseio incorreto não estão cobertos pela garantia.

# TABLE OF CONTENTS

<b>EN</b>	<b>Thermal Imaging Monocular</b>	<b>01</b>
<b>DE</b>	<b>Wärmebildmonokular</b>	<b>12</b>
<b>IT</b>	<b>Monocolare per imaging termico</b>	<b>23</b>
<b>FR</b>	<b>Monoculaire d'imagerie thermique</b>	<b>34</b>
<b>ES</b>	<b>Monocular de Imagen Térmica</b>	<b>45</b>
<b>CZ</b>	<b>Termovizní monokulární</b>	<b>56</b>
<b>PL</b>	<b>Monokular termowizyjny</b>	<b>67</b>
<b>SV</b>	<b>Termisk bildmonokuläret</b>	<b>78</b>
<b>HU</b>	<b>Hőképképző monokulár</b>	<b>89</b>
<b>PT</b>	<b>Monocular de Imagem Térmica</b>	<b>100</b>

## 01 PRODUCT FEATURES

- 2 in 1 multi-function: Specifically designed for handheld and helmet-mounted scenarios
- Minimum 1× magnification, suitable for walking when helmet-mounted
- Sensor resolution: ST3 Lite - 384×288 / ST6 Lite - 640×512
- Display screen: 1024×768
- 18650 replaceable battery with a length of 70mm
- Ergonomic design, comfortable to use

## 02 APP DESCRIPTION

For more features, please use RIX+ app.



As this product is an electronic device, it is recommended to read or download the latest manual on the RIX website or RIX+ app to obtain the most up-to-date product instructions.



RoHS

EN

DE

IT

FR

ES

CZ

PL

SV

HU

PT

# 03 PRODUCT DESCRIPTION

Series	STRIDE	STRIDE
Product	ST3 Lite	ST6 Lite
<b>Sensor</b>		
Resolution	384 × 288	640 × 512
Pixel pitch	12 μm	
NETD	< 20 mK	
Frame rate	50 Hz	
<b>Optics</b>		
Objective lens	15 mm, F1.0	25 mm, F1.0
Magnification	1× to 6×	
Field of view (H×V)	17.5° × 13.1°	
Digital zoom	1× / 2× / 4×	
Eye Relief	20 mm	
Diopter adjustment	-5D to +5D	
Detection Range	780 m / 852 yd	1300 m / 1423 yd
<b>Display</b>		
Type	OLED	
Resolution	1024 × 768	
<b>Video Recorder</b>		
Video / Photo Resolution	1024 × 768	
Video / Photo Format	.mp4 / .jpg	
Built-in Memory	32 GB	
<b>Environmental Characteristics</b>		
Degree of Protection, IP code	IP67	
Operating temperature range	-20 °C to +50 °C / -4°F to 122 °F	

Series	STRIDE	STRIDE
Product	ST3 Lite	ST6 Lite
<b>Connections and Compatibilities</b>		
Battery type	18650 (70 mm length)	
Wi-Fi	Support	
Operation time on battery pack (at t=25 °C/72 °F)	4 h	
External Power Supply	5V (Type-C USB)	
<b>Weight &amp; Size</b>		
Dimensions	120 × 71 × 47 mm / 4.7 × 2.8 × 1.9 inch	129 × 71 × 47 mm / 5.1 × 2.8 × 1.9 inch
Weight	190 g / 0.42 lb	205 g / 0.45 lb

### Tips

The results of operating time is tested at 25 °C/72 °F using RIX batteries. Battery life may vary based on temperature and usage conditions.

# 04 IN THE BOX

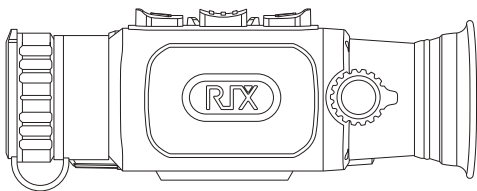

The STRIDE Series Thermal Imaging Monocular

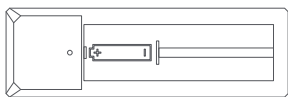

Battery Charger



USB Type C Cable



18650 Battery × 1 (70mm length)



Lens Cloth

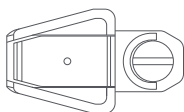

Adapter Kit × 2

(These two adapt kits are compatible only with specified production batches.)

# 05 PRODUCT APPEARANCE



# 06 DEVICE MODES

## Handheld Mode

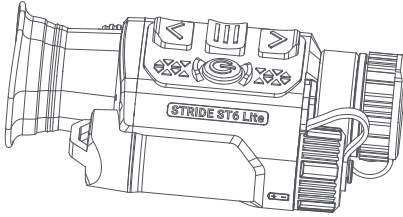

## Helmet Mode

**Mode 1:** Can be connected to the mounting bracket using the two M5 holes on the device.

**Step 1:** Attach the adapter kit to the device.

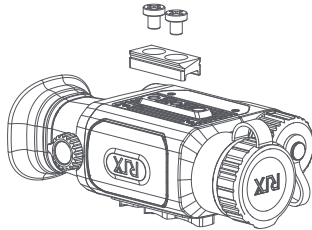
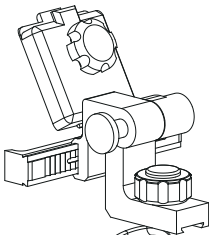

**Step 2:**  
Attach the helmet mount to the adapter kit.

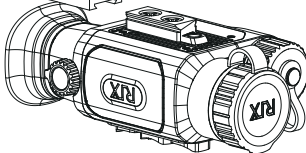

**Step 3:**

Attach the helmet mount to the helmet.

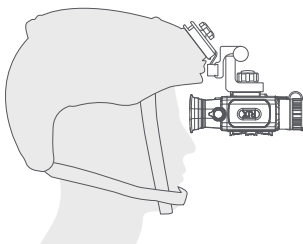

**Mode 2:** Can be connected to the mounting bracket using the 1/4 inch holes on the device.

**Step 1:** Attach the adapter kit to the device.

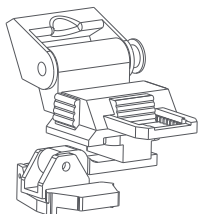
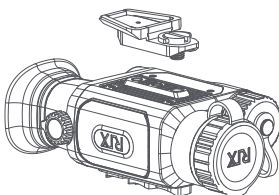

**Step 2:**

Attach the helmet mount to the adapter kit.

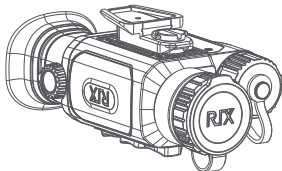

**Step 3:**

Attach the helmet mount to the helmet.

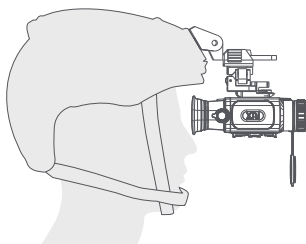

## 07 POWER SUPPLY

The STRIDE ST3 Lite / ST6 Lite is powered by a 18650 replaceable battery (70mm length).

When connected via Type-C, it powers the device to keep it running, but it does not charge the battery.

- Rotate the battery compartment cover until it is unscrewed.
- Install the battery into the compartment, positive (+) pole inward and negative (-) pole outward, as indicated by the symbols outside the battery compartment
- After inserting the battery, tighten the battery compartment cover.

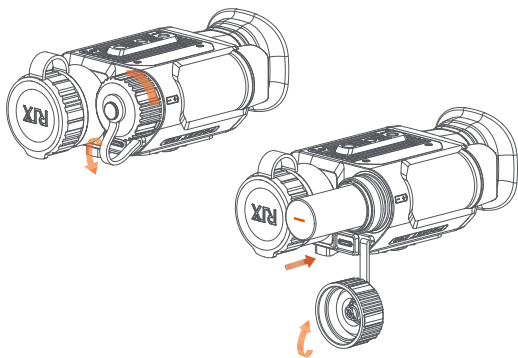

### WARNING

- Please remove the battery if the device is not in use for a long time.
- Do NOT power the device with a modified or damaged battery.
- Do not use the battery at a temperature above 122°F as it may reduce the service life of battery.

# 08 BUTTONS OPERATION

## Power on/off



**Press & Hold**  
Power on /off the device

## Standby/Exit Standby



**Press**  
Enter / Exit standby

## Home Screen



**Press**  
Switch digital zoom



**Press & Hold**  
Image correction



**Press**  
Switch image mode



**Press & Hold**  
Enter the setting menu



**Press**  
Start / Stop video recording



**Press & Hold**  
Take a photo

## Main Menu Screen



**Press**  
Scroll up



**Press**  
Return to the home screen with saving changes



**Press**  
scroll down



**Press**  
Adjust the parameters of a function

## 09 STATUS BAR

The status bar is located at the bottom of the screen and displays the operating status information of the device. From left to right:



1. Digital zoom: 1× / 1.5× / 3× / 6×
2. Weather mode: Sun/Rain
3. EIS (Electronic image stabilization): On/Off
4. Auto image correction mode: On/Off
5. Wi-Fi connection: On/Off
6. Clock
7. Battery level

# 10 MAIN MENU

On the home screen, press and hold the Menu button to open the main menu.

## Main Menu



Screen Brightness



Image Contrast



Automatic Standby



Auto Image Correction



Electric Image Stabilization



Weather Mode



Wi-Fi



Info



Languages

EN

DE

IT

FR

ES

CZ

PL

SV

HU

PT

## 01 PRODUKT MERKMALE

- 2-in-1-Multifunktion: Speziell für Handheld- und helmmontierte Szenarien entwickelt
- Mindestens 1× Vergrößerung, geeignet für das Gehen bei Helmmontage
- Sensorauflösung: ST3 Lite – 384×288 / ST6 Lite – 640×512
- Bildschirm: 1024 × 768
- Austauschbarer 18650-Akku mit einer Länge von 70 mm
- Ergonomisches Design, angenehm in der Nutzung

## 02 APP BESCHREIBUNG

Für weitere Funktionen verwenden Sie bitte die RIX+ App.



Da dieses Produkt ein elektronisches Gerät ist, wird empfohlen, die neueste Bedienungsanleitung auf der RIX-Website oder in der RIX+ App zu lesen oder herunterzuladen, um die aktuellsten Produktanweisungen zu erhalten.

# 03 PRODUKT BESCHREIBUNG

Serie	STRIDE	STRIDE
Produkt	ST3 Lite	ST6 Lite
<b>Sensor</b>		
Auflösung	384 × 288	640 × 512
Pixelabstand	12 µm	
NETD	< 20 mK	
Bildfrequenz	50 Hz	
<b>Optik</b>		
Objektivlinse	15 mm, F1,0	25 mm, F1,0
Vergößerung	1× bis 6×	
Sichtfeld (H × V)	17,5° × 13,1°	
Digitaler Zoom	1× / 2× / 4×	
Augenabstand	20 mm	
Dioptrieneinstellung	-5D bis +5D	
Detektionsreichweite	780 m / 852 yd	1300 m / 1423 yd
<b>Display</b>		
Typ	OLED	
Auflösung	1024 × 768	
<b>Videorekorder</b>		
Video-/Fotoauflösung	1024 × 768	
Video-/Fotoformat	.mp4 / .jpg	
Eingebauter Speicher	32 GB	
<b>Umwelteigenschaften</b>		
Schutzart, IP-Code	IP67	
Betriebstemperaturbereich	-20 °C bis +50 °C / -4 °F bis 122 °F	

Serie	STRIDE	STRIDE
Produkt	ST3 Lite	ST6 Lite
<b>Verbindungen und Kompatibilitäten</b>		
Akkutyp	18650 (70 mm Länge)	
WLAN	Unterstützt	
Betriebszeit mit Akkupack (bei 25 °C / 72 °F)	4 Std.	
Externe Stromversorgung	5V (USB-Typ-C)	
<b>Gewicht &amp; Abmessungen</b>		
Abmessungen	120 × 71 × 47 mm / 4,7 × 2,8 × 1,9 Zoll	129 × 71 × 47 mm / 5,1 × 2,8 × 1,9 Zoll
Gewicht	190 g / 0,42 lb	205 g / 0,45 lb

### Tipps

Die Betriebszeit wurde bei 25 °C/72 °F mit RIX-Akkus getestet. Die Akkulaufzeit kann je nach Temperatur und Nutzungsbedingungen variieren.

# 04 IM LIEFERUMFANG ENTHALTEN

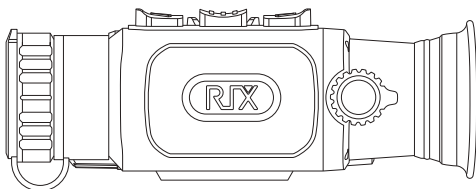

Das Wärmebildmonokular der STRIDE-Serie

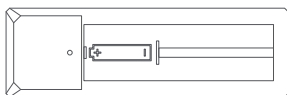

Akkuladegerät



USB-Typ-C-Kabel



18650-Akku × 1 (70 mm Länge)



Lintentuch

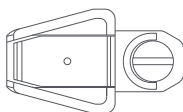

Adapter-Kit × 2

(Diese beiden Adapter-Kits sind nur mit bestimmten Produktionschargen kompatibel.)

# 05 PRODUKT ANSICHT



## 06 GERÄTE MODI

### Handheld-Modus

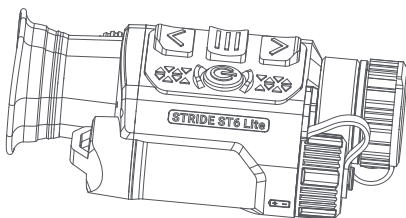

### Helm-Modus

**Modus 1:** Kann über die beiden M5-Löcher am Gerät mit der Halterung verbunden werden

**Schritt 1:** Bringen Sie das Adapter-Kit am Gerät an.

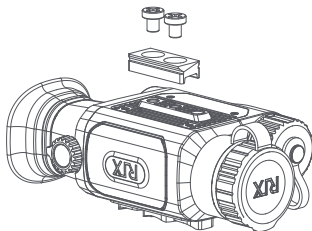
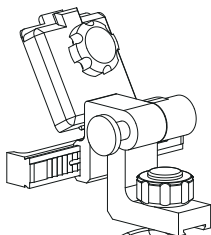

**Schritt 2:**

Befestigen Sie die Helmhalterung am Adapter-Kit.

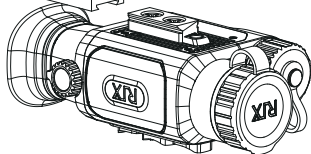

**Schritt 3:**

Befestigen Sie die Helmhalterung am Helm.

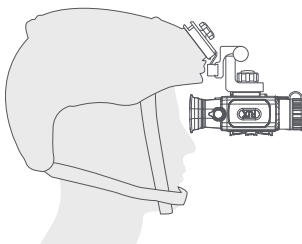

**Modus 2:** Kann über die 1/4-Zoll-Löcher am Gerät mit der Halterung verbunden werden.

**Schritt 1:** Bringen Sie das Adapter-Kit am Gerät an.

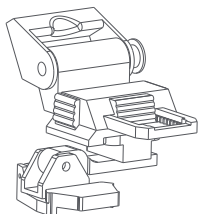
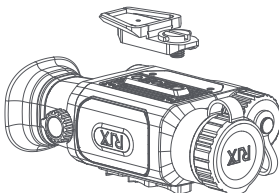

**Schritt 2:**

Befestigen Sie die Helmhalterung am Adapter-Kit.

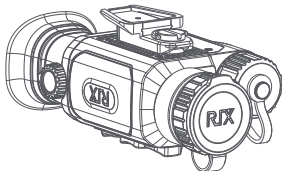

**Schritt 3:**

Befestigen Sie die Helmhalterung am Helm.

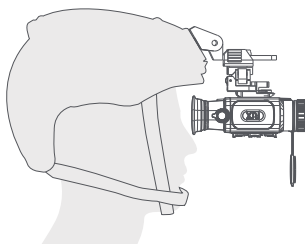

## 07 STROM VERSORGUNG

Das STRIDE ST3 Lite / ST6 Lite wird mit einem austauschbaren 18650-Akku (70 mm Länge) betrieben.

Bei Verbindung über USB-Typ-C wird das Gerät mit Strom versorgt und bleibt in Betrieb, der Akku wird jedoch nicht geladen.

- Drehen Sie die Batteriefachabdeckung, bis sie abgeschraubt ist.
- Legen Sie den Akku mit dem Pluspol (+) nach innen und dem Minuspol (-) nach außen in das Fach ein, entsprechend den Symbolen außerhalb des Akkufachs
- Nach dem Einsetzen des Akkus verschrauben Sie die Batteriefachabdeckung.

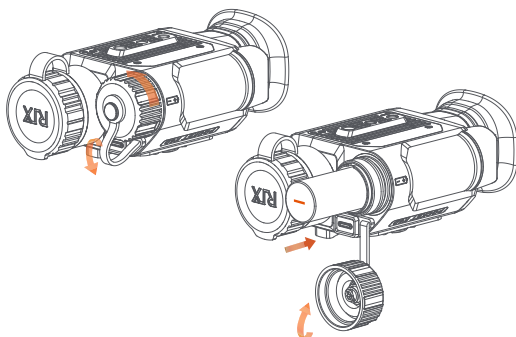

### WARNUNG

- Bitte entfernen Sie den Akku, wenn das Gerät längere Zeit nicht benutzt wird.
- Betreiben Sie das Gerät NICHT mit einem modifizierten oder beschädigten Akku.
- Verwenden Sie den Akku nicht bei Temperaturen über 122 °F, da dies die Lebensdauer des Akkus verkürzen kann.

# 08 TASTEN BEDIENUNG

## Ein-/Ausschalten



**Gedrückt halten**  
Gerät ein-/ausschalten



**Drücken**  
Standby aktivieren /  
deaktivieren

## Startbildschirm



**Drücken**  
Digitalen Zoom  
umschalten



**Gedrückt halten**  
Bildkorrektur



**Drücken**  
Bildmodus umschalten



**Gedrückt halten**  
Einstellungsmenü  
aufrufen



**Drücken**  
Videoaufnahme starten / beenden



**Gedrückt halten**  
Foto aufnehmen

## Hauptmenü-Bildschirm



**Drücken**  
Nach oben scrollen



**Drücken**  
Mit dem Speichern der  
Änderungen zum Startbild-  
schirm zurückkehren



**Drücken**  
Nach unten scrollen



**Drücken**  
Funktionsparameter  
einstellen

## 09 STATUS LEISTE

Die Statusleiste befindet sich unten im Bildschirm und zeigt die Betriebsinformationen des Geräts an. Von links nach rechts:











1. Digitaler Zoom: 1× / 1,5× / 3× / 6×
2. Wettermodus: Sonne / Regen
3. EIS (Elektronische Bildstabilisierung): Ein / Aus
4. Automatischer Bildkorrekturmodus: Ein / Aus
5. WLAN-Verbindung: Ein / Aus
6. Uhr
7. Akkustand

# 10 HAUPT MENÜ

Halten Sie auf dem Startbildschirm die Menütaste gedrückt, um das Hauptmenü zu öffnen.

## Hauptmenü

	Bildschirmhelligkeit
	Bildkontrast
	Automatischer Standby-Modus
	Automatische Bildkorrektur
	Elektronische Bildstabilisierung
	Wettermodus
	WLAN
	Info
	Sprachen

## 01 CARATTERISTICHE DEL PRODOTTO

- 2 in 1 multifunzione: Progettato specificamente per l'utilizzo manuale e con montaggio su casco
- Ingrandimento minimo 1×, adatto per camminare quando montato sul casco
- Risoluzione del sensore: ST3 Lite - 384×288 / ST6 Lite - 640×512
- Display: 1024×768
- Batteria sostituibile 18650 con lunghezza di 70 mm
- Design ergonomico, comodo da usare

## 02 DESCRIZIONE DELL'APP

Per ulteriori funzionalità, utilizzare l'app RIX+.



Essendo questo un dispositivo elettronico, si consiglia di consultare o scaricare il manuale più recente sul sito RIX o sull'app RIX+ per ottenere le istruzioni più aggiornate del prodotto.

EN

DE

IT

FR

ES

CZ

PL

SV

HU

PT

## 03 PRODOTTO DESCRIZIONE

Serie	STRIDE	STRIDE
Prodotto	ST3 Lite	ST6 Lite
<b>Sensore</b>		
Risoluzione	384 × 288	640 × 512
Passo pixel	12 µm	
NETD	< 20 mK	
Frequenza fotogrammi	50 Hz	
<b>Ottica</b>		
Lente dell'obiettivo	15 mm, F1,0	25 mm, F1,0
Ingrandimento	Da 1x a 6x	
Campo visivo (O × V)	17,5° × 13,1°	
Zoom digitale	1x / 2x / 4x	
Distanza della pupilla d'uscita	20 mm	
Regolazione diottrica	Da -5D a +5D	
Portata di rilevamento	780 m / 852 yd	1300 m / 1423 yd
<b>Display</b>		
Tipo	OLED	
Risoluzione	1024 × 768	
<b>Registratore video</b>		
Risoluzione video/foto	1024 × 768	
Formato video/foto	.mp4 / .jpg	
Memoria integrata	32 GB	
<b>Caratteristiche ambientali</b>		
Grado di protezione, codice IP	IP67	
Intervallo temperatura di funzionamento	Da -20 a +50 °C / Da -4 a 122 °F	

Serie	STRIDE	STRIDE
Prodotto	ST3 Lite	ST6 Lite
<b>Connessioni e compatibilità</b>		
Tipo di batteria	18650 (lunghezza 70mm)	
Wi-Fi	Supporta	
Autonomia con pacco batteria (a t=25 °C/72 °F)	4 ore	
Alimentazione esterna	5V (USB Tipo-C)	
<b>Peso e dimensione</b>		
Dimensioni	120 x 71 x 47 mm / 4,7 x 2,8 x 1,9 pollici	129 x 71 x 47 mm / 5,1 x 2,8 x 1,9 pollici
Peso	190 g / 0,42 lb	205 g / 0,45 lb

### Suggerimenti

I risultati del tempo di funzionamento sono stati testati a 25 °C/72 °F utilizzando batterie RIX. La durata della batteria può variare in base alla temperatura e alle condizioni di utilizzo.

# 04 NELLA SCATOLA

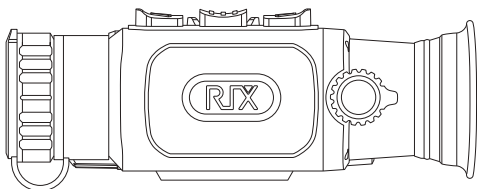

Il monocolo per immagini termiche della serie STRIDE

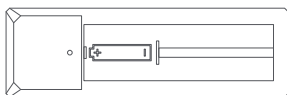

Caricabatterie



Cavo USB tipo-c



Batteria 18650 × 1 (lunghezza 70 mm)



Panno per obiettivo

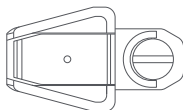

Kit adattatore × 2

(Questi due kit adattatori sono compatibili solo con specifici lotti di produzione.)

## 05 ASPETTO DEL PRODOTTO



## 06 MODALITÀ DISPOSITIVO

### Modalità Manuale

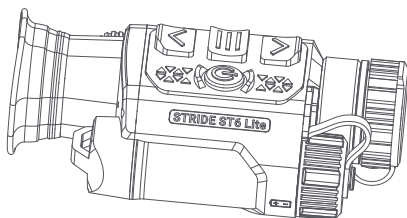

### Modalità Casco

**Modalità 1:** Può essere collegato alla staffa di montaggio utilizzando i due fori M5 sul dispositivo.

**Fase 1:** Fissare il kit adattatore al dispositivo.

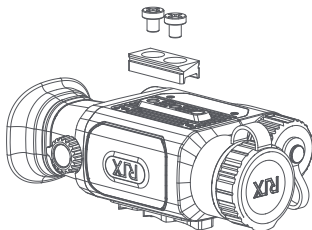
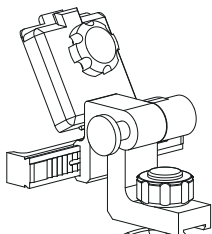

**Fase 2:**  
Fissare il supporto per casco al kit adattatore.

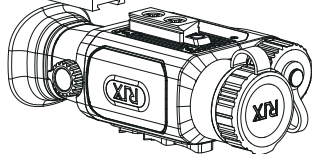

**Fase 3:**

Fissare il supporto per casco al casco.

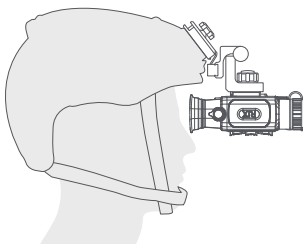

**Modalità 2:** Può essere collegato alla staffa di montaggio utilizzando i fori da 1/4 di pollice sul dispositivo.

**Fase 1:** Fissare il kit adattatore al dispositivo.

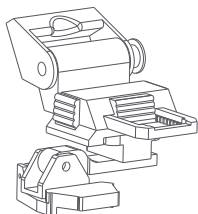
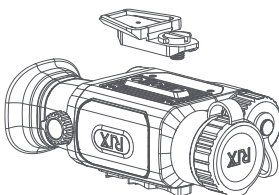

**Fase 2:**

Fissare il supporto per casco al kit adattatore.

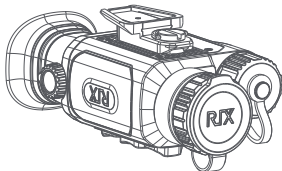

**Fase 3:**

Fissare il supporto per casco al casco.

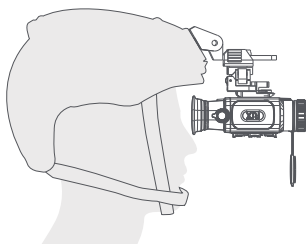

## 07 ALIMENTAZIONE

Il STRIDE ST3 Lite / ST6 Lite è alimentato da una batteria sostituibile 18650 (lunghezza 70mm).

Quando collegato via Type-C, alimenta il dispositivo per mantenerlo in funzione, ma non ricarica la batteria.

- Ruotare il coperchio del vano batteria fino a svitarlo completamente.
- Installare la batteria nel vano con il polo positivo (+) verso l'interno e il polo negativo (-) verso l'esterno, come indicato dai simboli all'esterno del vano batteria
- Dopo aver inserito la batteria, stringere il coperchio del vano batteria.

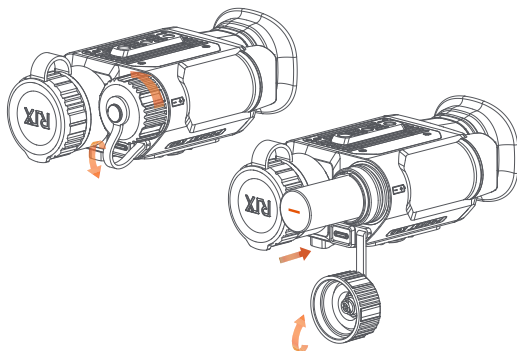

### Avvertenze

- Si prega di rimuovere la batteria se il dispositivo non viene utilizzato per un lungo periodo.
- NON alimentare il dispositivo con una batteria modificata o danneggiata.
- Non utilizzare la batteria a temperature superiori a 122°F poiché potrebbe ridurne la durata.

# 08 PULSANTI FUNZIONAMENTO

## Accensione/Spegnimento



**Tenere premuto**  
Accensione/spegnimento del dispositivo

## Modalità attesa / Uscire da modalità attesa



**Premi**  
Entrare/uscire da modalità attesa

## Schermata iniziale



**Premi**  
Cambiare zoom digitale



**Tenere premuto**  
Correzione dell'immagine



**Premi**  
Cambiare modalità immagine



**Tenere premuto**  
Accedi al menu impostazioni



**Premi**  
Avviare / Interrompere una registrazione video



**Tenere premuto**  
Scattare una foto

## Schermata del menu principale



**Premi**  
Scorri verso l'alto



**Premi**  
Tornare alla schermata iniziale salvando le modifiche



**Premi**  
Scorrimento in basso



**Premi**  
Regolare i parametri di una funzione

## 09 BARRA DI STATO

La barra di stato si trova nella parte inferiore dello schermo e visualizza le informazioni sullo stato operativo del dispositivo. Da sinistra a destra:











1. Zoom digitale: 1× / 1,5× / 3× / 6×
2. Modalità meteo: Sole/Pioggia
3. EIS (Stabilizzazione elettronica dell'immagine): On/off
4. Modalità correzione automatica dell'immagine: On/off
5. Connessione Wi-Fi: On/off
6. Orologio
7. Livello batteria

# 10 MENU PRINCIPALE

Nella schermata iniziale, tenere premuto il pulsante Menu per aprire il menu principale.

## Menu principale

	Luminosità dello schermo
	Contrasto dell'immagine
	Attesa Automatica
	Correzione automatica dell'immagine
	Stabilizzazione elettronica dell'immagine
	Modalità meteo
	Wi-Fi
	Info
	Lingua

EN

DE

IT

FR

ES

CZ

PL

SV

HU

PT

## 01 CARACTÉRISTIQUES DU PRODUIT

- Multifonction 2 en 1 : Conçu spécifiquement pour les scénarios de port à la main et de montage sur casque
- Grossissement minimum de 1×, adapté à la marche lorsqu'il est monté sur un casque
- Résolution du capteur : ST3 Lite - 384 × 288 / ST6 Lite - 640 × 512
- Écran d'affichage : 1 024 × 768
- Batterie 18650 remplaçable d'une longueur de 70 mm
- Conception ergonomique, utilisation confortable

## 02 DESCRIPTION DE L'APPLICATION

Pour plus de fonctionnalités, veuillez utiliser l'application RIX+.



Ce produit étant un appareil électronique, il est recommandé de lire ou de télécharger le dernier manuel sur le site web de RIX ou l'application RIX+ pour obtenir les instructions de produit les plus récentes.

# 03 DESCRIPTION DU PRODUIT

Séries	STRIDE	STRIDE
Produit	ST3 Lite	ST6 Lite
<b>Capteur</b>		
Résolution	384 × 288	640 × 512
Pas de pixel	12 µm	
NETD	< 20 mK	
Fréquence des frames	50 Hz	
<b>Optique</b>		
Objectif	15 mm, F1,0	25 mm, F1,0
Grossissement	1× à 6×	
Champ de vision (H × V)	17,5° × 13,1°	
Zoom numérique	1× / 2× / 4×	
Distance oculaire	20 mm	
Réglage dioptrique	-5 D à +5 D	
Portée de détection	780 m / 852 yd	1300 m / 1423 yd
<b>Affichage</b>		
Typ	OLED	
Résolution	1024 × 768	
<b>Enregistreur vidéo</b>		
Résolution vidéo / photo	1024 × 768	
Format vidéo / photo	.mp4 / .jpg	
Mémoire intégrée	32 Go	
<b>Caractéristiques environnementales</b>		
Degré de protection, code IP	IP67	
Plage de température de fonctionnement	-20 °C à +50 °C / -4 °F à 122 °F	

Séries	STRIDE	STRIDE
Produit	ST3 Lite	ST6 Lite
<b>Connexions et compatibilités</b>		
Type de batterie	18650 (longueur de 70 mm)	
Wi-Fi	Pris en charge	
Durée de fonctionnement sur le pack de batterie (à t = 25 °C / 72 °F)	4 h	
Alimentation électrique externe	5 V (USB-Typ-C)	
<b>Poids et taille</b>		
Dimensions	120 × 71 × 47 mm / 4,7 × 2,8 × 1,9 pouces	129 × 71 × 47 mm / 5,1 × 2,8 × 1,9 pouces
Poids	190 g / 0,42 livre	205 g / 0,45 livre

### Conseils

Les résultats de la durée de fonctionnement sont testés à 25 °C/72 °F en utilisant des batteries RIX. La durée de vie de la batterie peut varier en fonction de la température et des conditions d'utilisation.

# 04 CONTENU DANS LA CAISSE

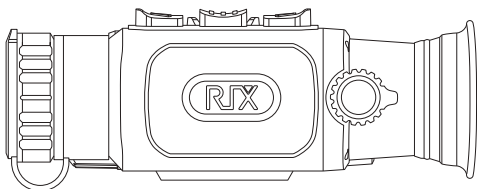

Monoculaire d'imagerie thermique de la Série STRIDE

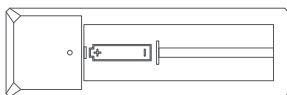

Chargeur de batterie



Câble de Type-C USB



Batterie 18650 × 1  
(longueur de 70 mm)



Chiffon de nettoyage  
pour l'objectif

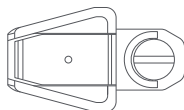

Kit d'adaptation × 2

(Ces deux kits d'adaptation sont compatibles uniquement avec les lots de production spécifiés.)

# 05 APPARENCE DU PRODUIT



## 06 MODES DE L'APPAREIL

### Mode portable

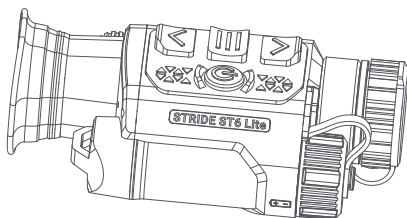

### Mode casque

**Mode 1:** Peut être connecté au support de montage en utilisant les deux trous M5 de l'appareil.

**Étape 1:** Fixez le kit d'adaptation à l'appareil.

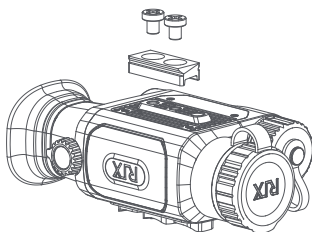
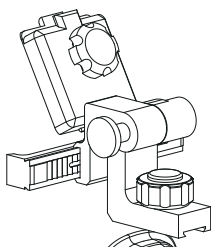

**Étape 2:** Fixez le support de casque au kit d'adaptation.

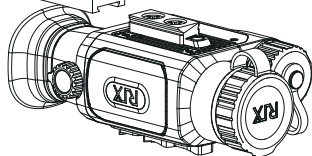

### Étape 3:

Fixez le support de casque au casque.

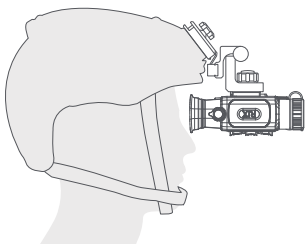

**Mode 2:** Peut être connecté au support de montage en utilisant les trous de 1/4 pouce sur l'appareil.

**Étape 1:** Fixez le kit d'adaptation à l'appareil.

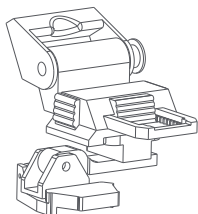
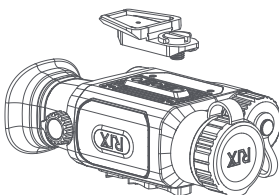

### Étape 2:

Fixez le support de casque au kit d'adaptation.

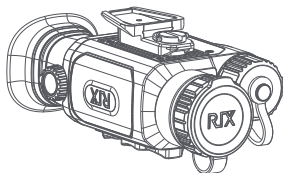

### Étape 3:

Fixez le support de casque au casque.

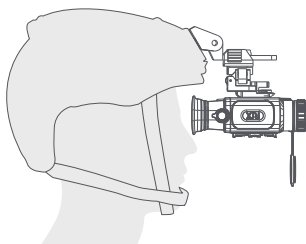

## 07 ALIMENTATION ÉLECTRIQUE

STRIDE ST3 Lite / ST6 Lite est alimentée par une batterie 18650 remplaçable (longueur de 70 mm).

Lorsqu'il est connecté via Type-C, il alimente l'appareil pour le faire fonctionner, mais ne charge pas la batterie.

- Tournez le couvercle du compartiment de la batterie jusqu'à ce qu'il soit dévissé.
- Installez la batterie dans le compartiment, le pôle positif (+) vers l'intérieur et le pôle négatif (-) vers l'extérieur, comme indiqué par les symboles à l'extérieur du compartiment de la batterie
- Après avoir inséré la batterie, serrez le couvercle du compartiment de la batterie.

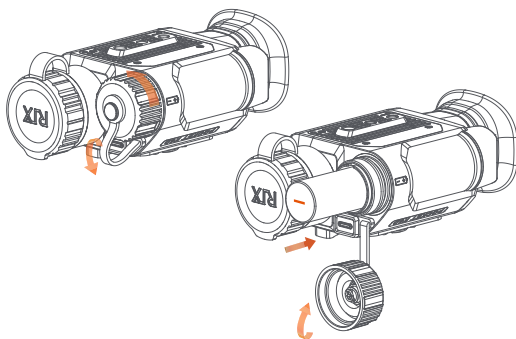

### AVERTISSEMENT

- Veuillez retirer la batterie si l'appareil n'est pas utilisé pendant une longue période.
- Ne PAS alimenter l'appareil avec une batterie modifiée ou endommagée.
- Ne pas utiliser la batterie à une température supérieure à 122 °F car cela peut réduire la durée de vie de la batterie.

# 08 BOUTONS OPÉRATION

## Allumer/éteindre



### Appuyer et maintenir

Allumer / éteindre  
l'appareil

## Veille/Quitter la veille



### Appuyer

Entrer / Sortir du mode  
veille

## Écran d'accueil



### Appuyer

Changer le zoom  
numérique



### Appuyer et maintenir

Correction de l'image



### Appuyer

Changer de mode  
image



### Appuyer et maintenir

Entrer dans le menu de  
paramètres



### Appuyer

Démarrer/Arrêter un enregis-  
trement vidéo



### Appuyer et maintenir

Prendre une photo

## Écran de menu principal



### Appuyer

Défilement vers le  
haut



### Appuyer

Retourner à l'écran  
d'accueil en enregistrant  
les modifications



### Appuyer

Sur le bouton de  
défilement vers le bas



### Appuyer

Ajuster les paramètres  
d'une fonction

## 09 BARRE D'ÉTAT

La barre d'état se trouve en bas de l'écran et affiche des informations sur l'état de fonctionnement de l'appareil. De gauche à droite :



1. Zoom numérique : 1× / 1,5× / 3× / 6×
2. Mode météo : Soleil/Pluie
3. SEI (Stabilisation électronique de l'image) : Allumer/Éteindre
4. Mode de correction automatique de l'image : Allumer/Éteindre
5. Connexion Wi-Fi : Allumer/Éteindre
6. Horloge
7. Niveau de la batterie

# 10 MENU PRINCIPAL

Appuyez sur le bouton de menu et maintenez-le enfoncé sur l'écran d'accueil pour ouvrir le menu principal.

## Menu principal



Luminosité de l'écran



Contraste de l'image



Mise en veille automatique



Correction automatique de l'image



Stabilisation électrique de l'image



Mode météo



Wi-Fi



Info



Langues

## 01 CARACTERÍSTICAS DEL PRODUCTO

- Multifunción 2 en 1: Diseñado específicamente para escenarios de uso portátil y montado en casco
- Ampliación mínima de 1x, adecuado para caminar cuando se usa montado en casco
- Resolución del sensor: ST3 Lite - 384x288/ST6 Lite - 640x512
- Pantalla de visualización: 1024x768
- Batería reemplazable 18650 con una longitud de 70 mm
- Diseño ergonómico, cómodo de usar

## 02 DESCRIPCIÓN DE LA APLICACIÓN

Utilice la aplicación RIX+ para más funciones.



Dado que este producto es un dispositivo electrónico, se recomienda leer o descargar el manual más reciente en el sitio web de RIX o en la aplicación RIX+ para obtener las instrucciones más actualizadas del producto.

EN

DE

IT

FR

ES

CZ

PL

SV

HU

PT

## 03 DESCRIPCIÓN DEL PRODUCTO

Serie	STRIDE	STRIDE
Producto	ST3 Lite	ST6 Lite
<b>Sensor</b>		
Resolución	384 x 288	640 x 512
Paso de píxeles	12 µm	
NETD	< 20 mK	
Velocidad de fotogramas	50 Hz	
<b>Ópticas</b>		
Lente de objetivo	15 mm, F1,0	25 mm, F1,0
Ampliación	1x a 6x	
Campo de visión (HxV)	17,5° x 13,1°	
Zoom digital	1x / 2x / 4x	
Alivio Ocular	20 mm	
Ajuste de dioptrías	-5D a +5D	
Rango de Detección	780 m / 852 yd	1300 m / 1423 yd
<b>Pantalla</b>		
Tipo	OLED	
Resolución	1024 x 768	
<b>Grabadora de Vídeos</b>		
Resolución de Vídeo/Foto	1024 x 768	
Formato de Vídeo/Foto	.mp4 / .jpg	
Memoria Integrada	32 GB	
<b>Características Ambientales</b>		
Grado de Protección, código IP	IP67	
Rango de temperatura de funcionamiento	-20 °C a +50 °C / -4 °F a 122 °F	

Serie	STRIDE	STRIDE
Producto	ST3 Lite	ST6 Lite
<b>Conexiones y Compatibilidades</b>		
Tipo de batería	18650 (70 mm de longitud)	
Wi-Fi	Soporte	
Tiempo de funcionamiento con el paquete de baterías (a t=25 °C/72 °F)	4 h	
Fuente de Alimentación Externa	5V (USB Tipo-C)	
<b>Peso y Tamaño</b>		
Dimensiones	120 x 71 x 47 mm / 4,7 x 2,8 x 1,9 pulgadas	129 x 71 x 47 mm / 5,1 x 2,8 x 1,9 pulgadas
Peso	190 g / 0,42 lb	205 g / 0,45 lb

### Consejos

Los resultados del tiempo de funcionamiento se han probado a 25 °C/72 °F utilizando baterías RIX. La vida útil de la batería puede variar según la temperatura y las condiciones de uso.

# 04 EN LA CAJA

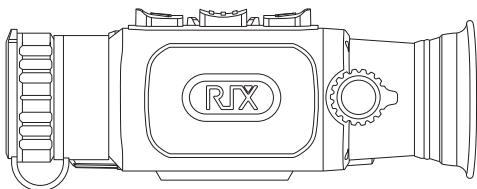

Monocular de Imagen Térmica de la Serie STRIDE

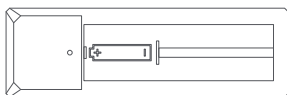

Cargador de Batería



Cable Tipo-C USB



Batería 18650×1 (70 mm de longitud)



Tela de la Lente

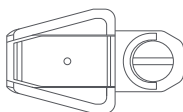

Kit de Adaptador×2

(Estos dos kits de adaptador solo son compatibles con los lotes de producción especificados.)

## 05 APARIENCIA DEL PRODUCTO



## 06 MODOS DE DISPOSITIVO

### Modo Portátil

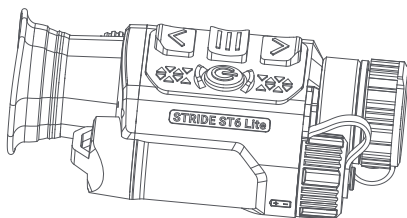

### Modo Casco

**Modo 1:** Puede conectarse al soporte de montaje utilizando los dos orificios M5 del dispositivo.

**Paso 1:** Fije el kit de adaptador al dispositivo.

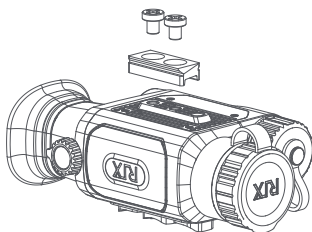
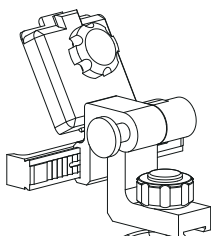

**Paso 2:**

Fije la montura de casco al kit de adaptador.

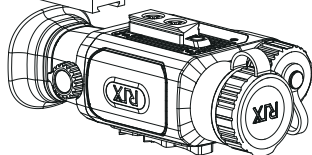

**Paso 3:**

Fije la montura de casco al casco.

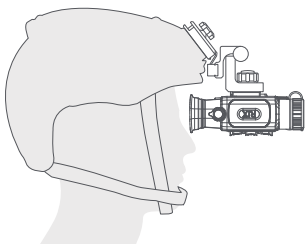

**Modo 2:** Puede conectarse al soporte de montaje utilizando los orificios de 1/4 pulgada del dispositivo.

**Paso 1:** Fije el kit de adaptador al dispositivo.

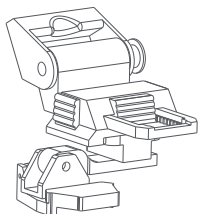
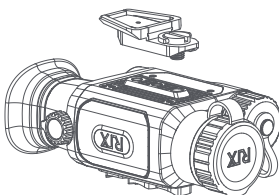

**Paso 2:**

Fije la montura de casco al kit de adaptador.

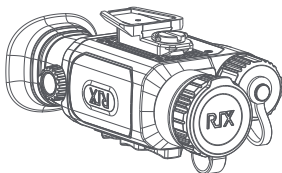

**Paso 3:**

Fije la montura de casco al casco.

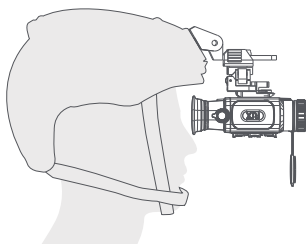

## 07 FUENTE DE ALIMENTACIÓN

El STRIDE ST3 Lite/ST6 Lite funciona con una batería reemplazable 18650 (70 mm de longitud).

Cuando se conecta mediante Tipo-C, alimenta el dispositivo para mantenerlo funcionando, pero no carga la batería.

- Gire la cubierta del compartimiento de batería hasta que se desenrosque.
- Instale la batería en el compartimiento, con el polo positivo (+) hacia dentro y el polo negativo (-) hacia fuera, tal y como indican los símbolos situados fuera del compartimiento de batería
- Después de insertar la batería, apriete la cubierta del compartimiento de batería.

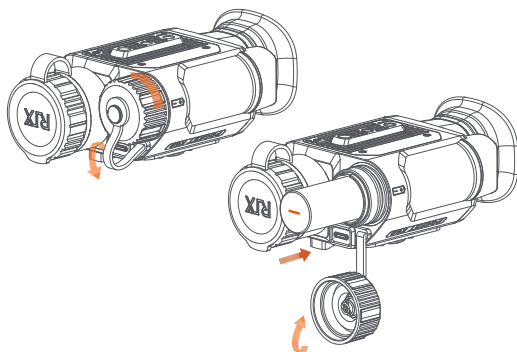

### ADVERTENCIA

- Retire la batería si no va a utilizar el dispositivo durante mucho tiempo.
- NO alimente el dispositivo con una batería modificada o dañada.
- No utilice la batería a una temperatura superior a 122 °F, ya que puede reducir la vida útil de la batería.

# 08 OPERACIÓN DE BOTONES

## Encendido/apagado



### Mantener Presionado

Encender/Apagar el dispositivo



### Presionar

Entrar/Salir de la espera

## Pantalla de Inicio



### Presionar

Cambiar el zoom digital



### Mantener Presionado

Corrección de imagen



### Presionar

Cambiar el modo de imagen



### Mantener Presionado

Entrar en el menú de ajuste



### Presionar

Iniciar/Finalizar una grabación de vídeo



### Mantener Presionado

Tomar una foto

## Pantalla del Menú Principal



### Presionar

Desplazarse hacia arriba



### Presionar

Regresar a la pantalla de inicio guardando los cambios



### Presionar

Desplazarse hacia abajo



### Presionar

Ajustar los parámetros de la función

## 09 BARRA DE ESTADO

La barra de estado se encuentra en la parte inferior de la pantalla y muestra la información del estado de funcionamiento del dispositivo. De izquierda a derecha:



1. Zoom digital: 1×/1,5×/3×/6×
2. Modo meteorológico: Sol/Lluvia
3. EIS (Estabilización Electrónica de Imagen): Activado/desactivado
4. Modo de corrección automática de imagen: Activado/desactivado
5. Conexión Wi-Fi: Activado/desactivado
6. Reloj
7. Nivel de la batería

# 10 MENÚ PRINCIPAL

En la pantalla de inicio, mantenga pulsado el botón Menú para abrir el menú principal.

## Menú Principal



Brillo de Pantalla



Contraste de Imagen



Espera automática



Corrección Automática de Imagen



Estabilización Electrónica de Imagen



Modo Meteorológico



Wi-Fi



Información



Idiomas

## 01 VLASTNOSTI PRODUKTU

- Multifunkční zařízení 2 v 1: Speciálně navržené pro scénáře ručního použití a montáže na přilbu
- Minimální zvětšení 1×, vhodné pro chůzi se zařízením namontovaným na přilbě
- Rozlišení senzoru: ST3 Lite: 384 × 288 / ST6 Lite: 640 × 512
- Obrazovka: 1024 × 768
- Vyměnitelná baterie 18650 dlouhá 70 mm
- Ergonomický design, pohodlné používání

## 02 POPIS APLIKACE

Pro více funkcí použijte aplikaci RIX+.



Jelikož se jedná o elektronické zařízení, doporučujeme si přečíst nebo stáhnout nejnovější návod k použití na webových stránkách společnosti RIX nebo v aplikaci RIX+, abyste získali nejaktuálnější pokyny k výrobku.

# 03 POPIS PRODUKTU

Řada	STRIDE	STRIDE
Produkt	ST3 Lite	ST6 Lite
<b>Senzor</b>		
Rozlišení	384 × 288	640 × 512
Rozteč pixelů	12 μm	
NETD	< 20 mK	
Snímková frekvence	50 Hz	
<b>Optika</b>		
Objektiv	15 mm, F1,0	25 mm, F1,0
Zvětšení	1x až 6x	
Zorné pole (H × V)	17,5° × 13,1°	
Digitální zoom	1x / 2x / 4x	
Oční reliéf	20 mm	
Dioptrická korekce	-5D až +5D	
Detekční vzdálenost	780 m / 852 yd	1300 m / 1423 yd
<b>Zobrazit</b>		
Typ	OLED	
Rozlišení	1024 × 768	
<b>Záznam videa</b>		
Rozlišení videa/fotografií	1024 × 768	
Formát videa/fotek	.mp4 / .jpg	
Vestavěná paměť	32 GB	
<b>Charakteristiky prostředí</b>		
Stupeň krytí, IP kód	IP67	
Provozní teplota	-20 °C až +50 °C / -4 °F až 122 °F	

Řada	STRIDE	STRIDE
Produkt	ST3 Lite	ST6 Lite
<b>Připojení a kompatibilita</b>		
Typ baterie	18650 (délka 70mm)	
Wi-Fi	Podpora	
Provozní doba baterie (při t=25 °C/72 °F)	4 h	
Externí zdroj napájení	5V (USB-C)	
<b>Hmotnost a velikost</b>		
Rozměry	120 × 71 × 47 mm / 4,7 × 2,8 × 1,9 palce	129 × 71 × 47 mm / 5,1 × 2,8 × 1,9 palce
Hmotnost	190 g / 0,42 lb	205 g / 0,45 lb

### Tipy

Provozní doba baterie byla testována při 25 °C / 72 °F s bateriemi RIX.

Životnost baterie se může lišit v závislosti na teplotě a podmínkách použití.

# 04<sup>V</sup> KRABICI

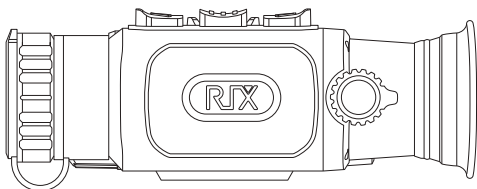

Termovizní monokulární dalekohled řady STRIDE

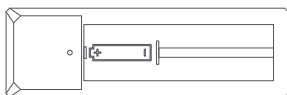

Nabíječka baterie



Utěrka na objektiv



1× baterie 18650 (délka 70 mm)



Utěrka na objektiv

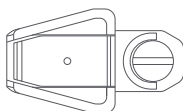

2× sada adaptéru

(Tyto dvě adaptační sady jsou kompatibilní pouze s uvedenými výrobními šaržemi.)

# 05 VZHLED PRODUKTU



# 06 REŽIMY ZAŘÍZENÍ

## Ruční režim

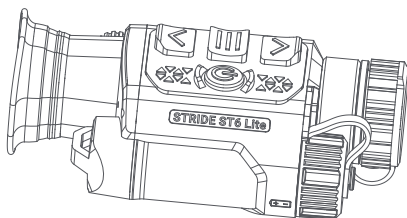

## Přilbový režim

**Režim 1:** Připojení k montážnímu držáku je možné pomocí dvou otvorů M5 na zařízení.

**Krok 1:** Připevněte sadu adaptéru k zařízení.

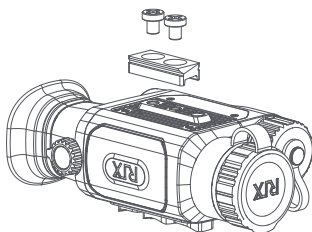
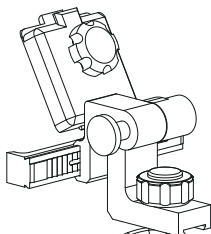

**Krok 2:**

Připevněte držák na přilbu k sadě adaptéru

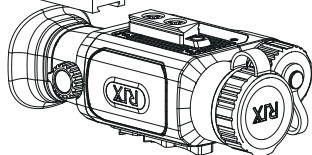

**Krok 3:**

Přípevněte držák na přilbu k přilbě.

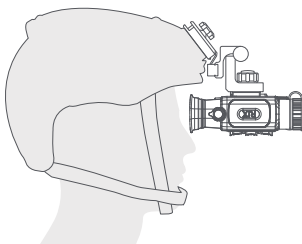

**Režim 2:** Připojení k montážnímu držáku je možné pomocí otvoru 1/4 palce na zařízení.

**Krok 1:** Přípevněte sadu adaptéru k zařízení.

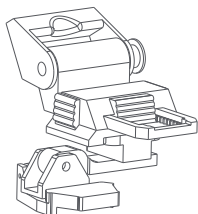
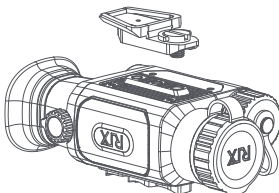

**Krok 2:**

Přípevněte držák na přilbu k sadě adaptéru.

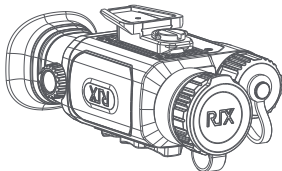

**Krok 3:**

Přípevněte držák na přilbu k přilbě.

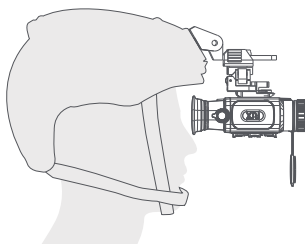

## 07 NAPÁJENÍ

STRIDE ST3 Lite / ST6 Lite je napájen vyměnitelnou baterií 18650 (délka 70 mm).

Když je připojen kabel USB-C, napájí zařízení a udržuje ho v provozu, ale nenabíjí baterii.

- Otáčejte krytem přihrádky na baterii, dokud jej neodšroubujete.
- Vložte baterii do přihrádky kladným (+) pólem směrem dovnitř a záporným (-) pólem směrem ven, podle symbolů vně přihrádky na baterii
- Po vložení baterie kryt přihrádky na baterii utáhněte.

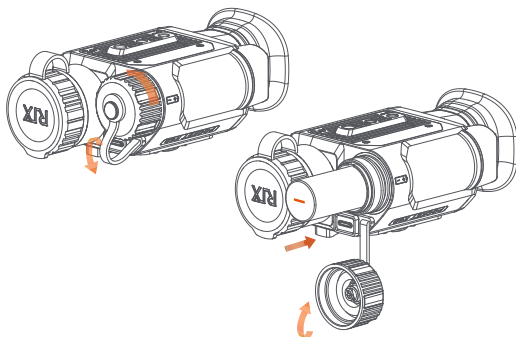

### VAROVÁNÍ

- Pokud zařízení delší dobu nepoužíváte, vyjměte baterii.
- Zařízení s upravenou nebo poškozenou baterií NENAPÁJEJTE.
- Nepoužívejte baterii při teplotě vyšší než 122 °F (50 °C), protože to může snížit životnost baterie.

# 08 FUNKCE TLAČÍTEK

## Zapnuto/Vypnuto



### Stisknout a podržet

Zapnutí/vypnutí zařízení



### Stisknutí

Vstup do pohotovostního režimu / ukončení pohotovostního režimu

## Domovská obrazovka



### Stisknutí

Přepnout digitální zoom



### Stisknout a podržet

Korekce obrazu



### Stisknutí

Přepnout režim obrazu



### Stisknout a podržet

Vstup do menu nastavení



### Stisknutí

Spustit/zastavit nahrávání videa



### Stisknout a podržet

Pořízení fotografie

## Hlavní menu



### Stisknutí

Posunutí nahoru



### Stisknutí

Návrat na domovskou obrazovku s uložením změn



### Stisknutí

Posunutí dolů



### Stisknutí

Upravení parametrů vybrané funkce

## 09 STAVOVÝ ŘÁDEK

Stavový řádek se nachází v dolní části obrazovky a zobrazuje informace o aktuálním stavu zařízení. Zleva doprava:



1. Digitální zoom: 1×/1,5×/3×/6×
2. Režim počasí: slunce/déšť
3. EIS (elektronická stabilizace obrazu): zapnuto/vypnuto
4. Režim automatické korekce obrazu: zapnuto/vypnuto
5. Wi-Fi připojení: zapnuto/vypnuto
6. Hodiny
7. Stav baterie

# 10 Hlavní MENU

Na domovské obrazovce stisknutím a podržením tlačítka Menu otevřete hlavní menu.

## Hlavní menu



Jas obrazovky



Kontrast obrazu



Automatický pohotovostní režim



Automatická korekce obrazu



Elektronická stabilizace obrazu



Režim počasí



Wi-Fi



Info



Jazyky

## 01 CECHY PRODUKTU

- 2 w 1, wielofunkcyjne urządzenie: Specjalnie zaprojektowane do użytkowania w trybie ręcznym oraz do montowania na kasku
- Minimalne powiększenie 1x, odpowiednie do chodzenia podczas użytkowania na kasku
- Rozdzielczość czujnika: ST3 Lite – 384×288/ST6 Lite – 640×512
- Ekran wyświetlacza: 1024×768
- Wymienna bateria 18650 o długości 70 mm
- Ergonomiczna konstrukcja, wygodna w użyciu

## 02 OPIS APLIKACJI

Skorzystaj z RIX + aplikacji, aby uzyskać więcej funkcji.



Ponieważ niniejszy produkt jest urządzeniem elektronicznym, zaleca się przeczytanie lub pobranie najnowszej instrukcji na stronie internetowej RIX lub w aplikacji RIX+, aby poznać najbardziej aktualne informacje o produkcie.

EN

DE

IT

FR

ES

CZ

PL

SV

HU

PT

<b>Seria</b>	<b>STRIDE</b>	<b>STRIDE</b>
<b>Produkt</b>	<b>ST3 Lite</b>	<b>ST6 Lite</b>
<b>Czujnik</b>		
Rozdzielczość	384 × 288	640 × 512
Rozstaw pikseli	12 μm	
NETD	< 20 mK	
Częstotliwość odświeżania	50 Hz	
<b>Optyka</b>		
Obiektyw	15 mm, F1,0	25 mm, F1,0
Powiększenie	1x do 6x	
Pole widzenia (H × V)	17,5° × 13,1°	
Cyfrowy zoom	1x / 2x / 4x	
Oddalenie źrenicy wyjściowej	20 mm	
Regulacja dioptrii	-5D do +5D	
Zasięg wykrywania	780 m / 852 yd	1300 m / 1423 yd
<b>Wyświetlacz</b>		
Typ	OLED	
Rozdzielczość	1024 × 768	
<b>Rejestrator wideo</b>		
Rozdzielczość wideo/zdjęć	1024 × 768	
Format wideo/zdjęcia	.mp4 / .jpg	
Wbudowana pamięć	32 GB	
<b>Charakterystyka środowiskowa</b>		
Stopień ochrony, kod IP	IP67	
Zakres temperatury pracy	Od -20°C do +50°C/od -4°F do 122°F	

<b>Seria</b>	<b>STRIDE</b>	
<b>Produkt</b>	<b>ST3 Lite</b>	<b>ST6 Lite</b>
<b>Połączenia i kompatybilność</b>		
Typ baterii	18650 (długość 70 mm)	
Wi-Fi	Obsługiwane	
Czas pracy na zestawie baterii (przy temperaturze równej 25°C/72°F)	4 godz	
Zewnętrzne źródło zasilania	5 V (USB typu C)	
<b>Waga i rozmiar</b>		
Wymiary	120 × 71 × 47 mm / 4,7 × 2,8 × 1,9 cala	129 × 71 × 47 mm / 5,1 × 2,8 × 1,9 cala
Waga	190 gramów/0,42 funta	205 gramów/0,45 funta

### **Wskazówki**

Wyniki czasu pracy sprawdzono w temperaturze 25°C/72°F przy użyciu akumulatorów RIX. Czas pracy baterii może się różnić w zależności od temperatury i warunków użytkowania.

# 04 ZAWARTOŚĆ OPAKOWANIA

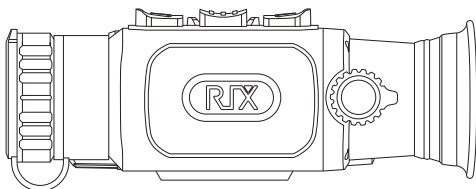

Monokular termowizyjny serii STRIDE

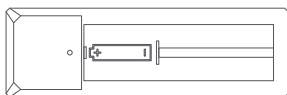

Ładowarka



Kabel USB typu C



Bateria 18650 × 1 (długość 70 mm)



Ściereczka do obiektywu

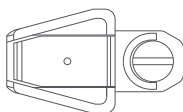

Zestaw adapterów × 2

(Te dwa zestawy adapterów są kompatybilne wyłącznie z określonymi partiami produkcyjnymi.)

# 05 WYGLĄD PRODUKTU



## 06 TRYBY URZĄDZENIA

### Tryb ręczny

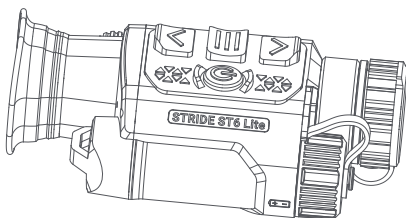

### Tryb kasku

**Tryb 1:** Może być połączony z uchwytem montażowym za pomocą dwóch otworów M5 w urządzeniu.

**Krok 1:** Zamocuj zestaw adaptera do urządzenia.

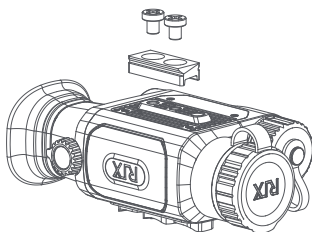
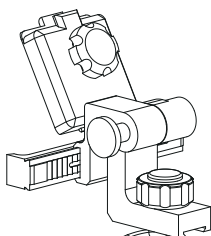

**Krok 2:**  
Zamocuj uchwyt hełmowy do zestawu adaptera.

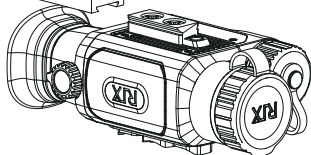

**Krok 3:**

Zamocuj uchwyt kasku do kasku.

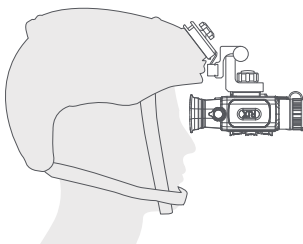

**Tryb 2:** Może być połączony z uchwytem montażowym za pomocą otworów 1/4 cala w urządzeniu.

**Krok 1:** Zamocuj zestaw adaptera do urządzenia.

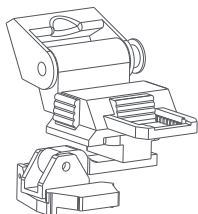
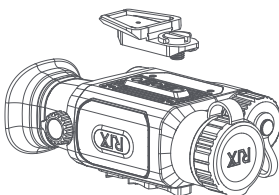

**Krok 2:**

Zamocuj uchwyt hełmowy do zestawu adaptera.

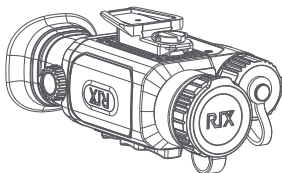

**Krok 3:**

Zamocuj uchwyt kasku do kasku.

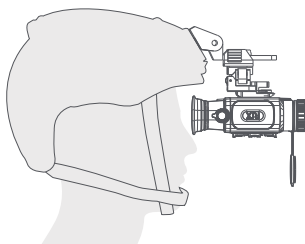

## 07 ZASILANIE

STRIDE ST3 Lite / ST6 Lite jest zasilany wymienną baterią 18650 (długość 70 mm).

Po podłączeniu przez kabel typu C zasilanie podtrzymuje pracę urządzenia, ale nie ładuje baterii.

- Obróć pokrywę zasobnika na baterię, aż zostanie odkręcona.
- Włóż baterię do komory: biegun dodatni (+) do środka, a biegun ujemny (-) na zewnątrz, zgodnie z oznaczeniami na obudowie zasobnika na baterię
- Po włożeniu baterii dokręć pokrywę zasobnika na baterię.

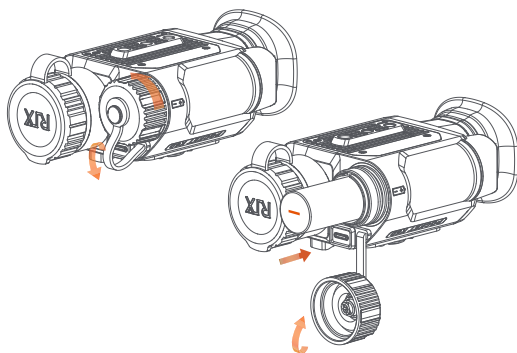

### Ostrzeżenie

- Wyjmij baterię, jeśli urządzenie nie będzie używane przez dłuższy czas.
- Nie zasilaj urządzenia zmodyfikowaną lub uszkodzoną baterią.
- Nie używaj baterii w temperaturze powyżej 122°F, ponieważ może to skrócić jej żywotność.

# 08 PRZYCISKI OBSŁUGA

## Włącz/wyłącz zasilanie



**Naciśnij i przytrzymaj**  
Włączanie/wyłączanie urządzenia

## Tryb czuwania/wyjdz z trybu czuwania



**Naciśnij**  
Wejście/wyjście ze stanu czuwania

## Ekran główny



**Naciśnij**  
Przełącz powiększenie cyfrowe

**Naciśnij i przytrzymaj**  
Korekta obrazu



**Naciśnij**  
Przełącz trybu obrazu

**Naciśnij i przytrzymaj**  
Wejście do menu ustawień



**Naciśnij**  
Rozpocznij/zatrzymaj nagrywanie wideo



**Naciśnij i przytrzymaj**  
Zrób zdjęcie

## Ekran Menu główne



**Naciśnij**  
Przewiń w górę



**Naciśnij**  
Wróć do ekranu głównego z zapisanymi zmianami



**Naciśnij**  
Przewinięcie w dół



**Naciśnij**  
Dostosuj parametry funkcji

## 09 PASEK STANU

Pasek stanu znajduje się na dole ekranu i wyświetla informacje o stanie pracy urządzenia. Od lewej do prawej:











1. Cyfrowy zoom: 1× / 1.5× / 3× / 6×
2. Tryb pogody: Słońce/deszcz
3. EIS (elektroniczna stabilizacja obrazu): Włącz/wyłącz
4. Tryb automatycznej korekty obrazu: Włącz/wyłącz
5. Połączenie Wi-Fi: Włącz/wyłącz
6. Zegar
7. Poziom naładowania baterii

# 10 MENU GŁÓWNE

Na ekranie głównym naciśnij i przytrzymaj przycisk Menu, aby otworzyć menu główne.

## Menu główne

	Jasność ekranu
	Kontrast obrazu
	Automatyczny tryb czuwania
	Automatyczna korekta obrazu
	Elektroniczna stabilizacja obrazu
	Tryb pogody
	Wi-Fi
	Informacje
	Języki

## 01 PRODUKTENS FUNKTIONER

- 2 i 1 multifunktion: Särskilt utformad för handhållen användning och hjälmmonterade scenarier
- Minst 1× förstöringsgrad, lämplig för promenad vid hjälmmontering
- Sensorupplösning: ST3 Lite - 384×288 / ST6 Lite - 640×512
- Bildskärm: 1024×768
- 18650 utbytbart batteri med en längd på 70 mm
- Ergonomisk design, bekväm i bruk

## 02 APP BESKRIVNING

Använd appen RIX+ för fler funktioner.



Eftersom denna produkt är en elektronisk enhet rekommenderas det att du läser eller laddar ner den senaste bruksanvisningen på RIX webbplats eller appen RIX+ för att få de mest aktuella produktinstruktionerna.

# 03 PRODUKTBESKRIVNING

Serier	STRIDE	STRIDE
Produkt	ST3 Lite	ST6 Lite
<b>Sensor</b>		
Upplösning	384 × 288	640 × 512
Pixelavstånd	12 µm	
NETD	< 20 mK	
Bildhastighet	50 Hz	
<b>Optik</b>		
Objektivlins	15 mm, F1,0	25 mm, F1,0
Förstoringsgrad	1x till 6x	
Synfält (H×V)	17,5° × 13,1°	
Digital-zoom	1x / 2x / 4x	
Ögonavstånd	20 mm	
Dioptrijustering	-5D till +5D	
Detektionsområde	780 m / 852 yd	1300 m / 1423 yd
<b>Display</b>		
Typ	OLED	
Upplösning	1024 × 768	
<b>Videospelare</b>		
Video- / fotoupplösning	1024 × 768	
Video- / fotoformat	.mp4 / .jpg	
Inbyggt minne	32 GB	
<b>Miljöegenskaper</b>		
Skyddsgrad, IP-kod	IP67	
Driftstemperaturområde	-20 °C till +50 °C / -4 °F till 122 °F	

Serier	STRIDE	STRIDE
Produkt	ST3 Lite	ST6 Lite
<b>Anslutningar och kompatibilitet</b>		
Batterityp	18650 (längd på 70 mm)	
Wi-Fi	Stöd	
Drifttid med batteripaket (vid t=25 °C/72 °F)	5 h	
Extern strömförsörjning	5V (Typ C USB)	
<b>Vikt och storlek</b>		
Dimensioner	120 × 71 × 47 mm / 4,7 × 2,8 × 1,9 tum	129 × 71 × 47 mm / 5,1 × 2,8 × 1,9 tum
Vikt	190 g / 0,42 lb	205 g / 0,45 lb

### Tips

Resultatet av drifttiden är provad vid 25 °C / 72 °F med RIX-batterier. Drifttid för batteri kan variera efter temperatur och användningsförhållanden.

# 04! FÖRPACKNINGEN

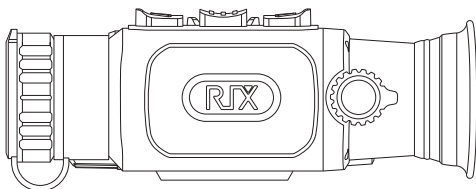

STRIDE-serien termisk bildmonokuläret

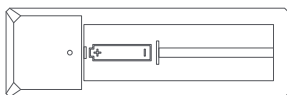

Batteriladdare



USB Typ-C-kabel



18650-batteri × 1 (längd på 70 mm)



Linsduk

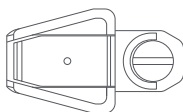

Adaptersats × 2

(Dessa två adaptersatser är endast kompatibla med angivna produktionsatser.)

# 05 PRODUKTENS UTSEENDE



# 06 ENHETS LÄGEN

## Handhållet läge

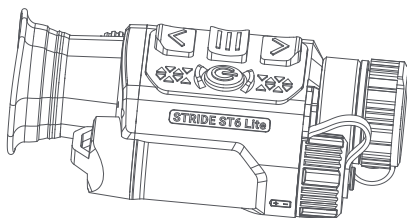

## Hjälmläge

**Läge 1:** Kan anslutas till monteringsfästet via de två M5-hålen på enheten.

**Steg 1:** Fäst adaptersatsen på enheten.

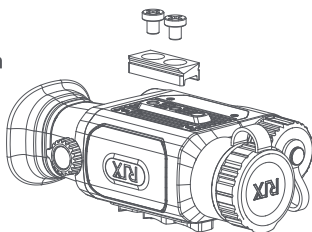
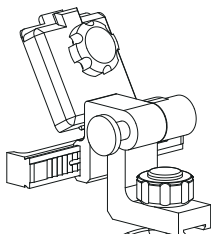

**Steg 2:**  
Fäst hjälmfästet på adaptersatsen.

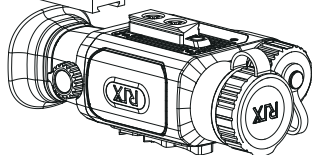

**Steg 3:**

Fäst hjälmfästet på hjälmen.

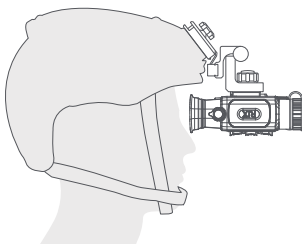

**Läge 2:** Kan anslutas till monteringsfästet via 1/4 tums-hålen på enheten.

**Steg 1:** Fäst adaptersatsen på enheten.

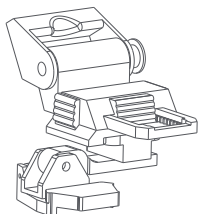
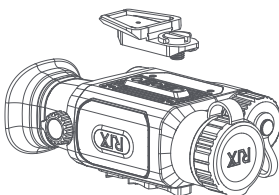

**Steg 2:**

Fäst hjälmfästet på adaptersatsen.

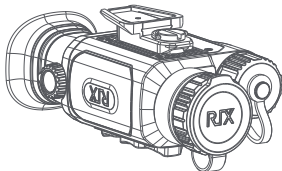

**Steg 3:**

Fäst hjälmfästet på.

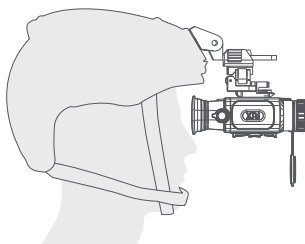

## 07 STRÖM FÖRSÖRJNING

STRIDE ST3 Lite / ST6 Lite drivs av ett 18650 utbytbart batteri (längd på 70 mm).

Vid anslutning via Typ-C förses enheten med ström för fortsatt drift, men batteriet laddas inte.

- Vrid locket till batterifacket tills det skruvas loss.
- Sätt i batteriet i facket med pluspolen (+) inåt och minuspolen (-) utåt, enligt symbolerna på utsidan av batterifacket
- Efter isättning av batteriet, dra åt locket till batterifacket.

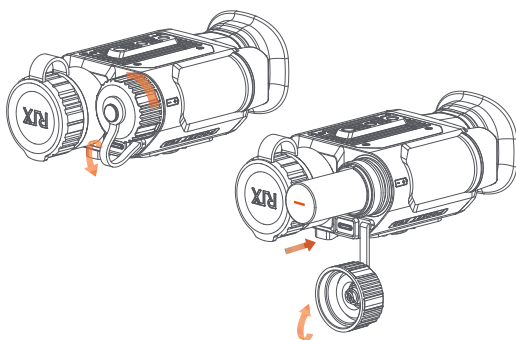

### VARNING

- Ta bort batteriet om enheten inte ska användas under en längre tid.
- Använd INTE ett modifierat eller skadat batteri för att driva enheten.
- Använd inte batteriet vid temperaturer över 122 °F (50 °C), eftersom detta kan förkorta batteriets livslängd.

# 08 KNAPPAR DRIFT

## Ström På/Av



### Håll intryckt

Slå på/stäng av enheten

## Standby/Avsluta standby



### Tryck

Gå till/avsluta standby

## Hem-skärm



### Tryck

Växla digital-zoom



### Håll intryckt

Bildkorrigering



### Tryck

Växla bildläge



### Håll intryckt

Gå till inställningsmenyn



### Tryck

Starta / Stoppa videoinspelning



### Håll intryckt

Ta ett foto



## Skärm för huvudmeny



### Tryck

Bläddra upp



### Tryck

Återgå till hem-skärmen med sparade ändringar



### Tryck

På bläddra ner



### Tryck

Justera parametrarna för en funktion

## 09 STATUS FÄLT

Statusfältet finns längst ned på skärmen och visar information om enhetens driftstatus. Från vänster till höger:











1. Digital-zoom: 1× / 1,5× / 3× / 6×
2. Väderläge: Sol/Regn
3. EIS (Elektronisk bildstabilisering): På/av
4. Läge för automatisk bildkorrigering: På/av
5. Wi-Fi-anslutning: På/av
6. Klocka
7. Batterinivå

# 10 HUVUDMENY

Håll knappen Meny intryckt på hem-skärmen för att öppna huvudmenyn.

## Huvudmeny

	Skärmens ljusstyrka
	Bildkontrast
	Automatisk standby
	Automatisk bildkorrigering
	Elektronisk bildstabilisering
	Väderläge
	Wi-Fi
	Info
	Språk

## 01 TERMÉKJELLEMZŐK

- 2 az 1-ben multifunkciós: Kifejezetten kézi és sisakra szerelhető esetekhez tervezve
- Minimum 1x-es nagyítás, sisakra szerelve sétához megfelelő
- Érzékelő felbontása: ST3 Lite – 384 × 288/ST6 Lite – 640 × 512
- Kijelző képernyő: 1024 × 768
- 18650-es cserélhető akkumulátor, 70 mm hosszú
- Ergonómikus kialakítás, kényelmes használat

## 02 ALKALMAZÁS LEÍRÁSA

További jellemzőkért kérjük használja a RIX + alkalmazást.



Mivel a jelen termék elektronikus eszköz, a termék lehető legnaprakészebb használati útmutatójáért javasolt a legfrissebb kézikönyv elolvasása vagy letöltése a RIX weboldaláról vagy a RIX+ alkalmazásból.

EN

DE

IT

FR

ES

CZ

PL

SV

HU

PT

# 03 TERMÉK LEÍRÁS

Sorozat	STRIDE	STRIDE
Termék	ST3 Lite	ST6 Lite
<b>Érzékelő</b>		
Felbontás	384 × 288	640 × 512
Pixelméret	12 µm	
NETD	< 20 mK	
Képkocka sebesség	50 Hz	
<b>Optika</b>		
Objektívlencse	15 mm, F1,0	25 mm, F1,0
Nagyítás	1 és 6x között	
Látómező (V × F)	17,5° × 13,1°	
Digitális zoom	1x / 2x / 4x	
Szemkönyítés	20 mm	
Dioptria beállítás	-5D és +5D között	
Észlelési tartomány	780 m / 852 yd	1300 m / 1423 yd
<b>Kijelző</b>		
Típus	OLED	
Felbontás	1024 × 768	
<b>Videórögzítő</b>		
Videó-/fényképfelbontás	1024 × 768	
Videó-/képformátum	.mp4 / .jpg	
Beépített memória	32 GB	
<b>Környezeti jellemzők</b>		
Védelmi fokozat, IP-kód	IP67	
Működési hőmérséklet tartomány	-20 °C és +50 °C / -4 °F és 122 °F között	

Sorozat	STRIDE	STRIDE
Termék	ST3 Lite	ST6 Lite
<b>Csatlakozások és kompatibilitások</b>		
Akkumulátor típusa	18650 (70 mm hosszú)	
Wi-Fi	Támogatás	
Üzemidő az akkumulátorról működtetve (t = 25 °C-on/72 °F-en)	4 óra	
Külső tápegység	5 V (USB C-típusú)	
<b>Súly és méret</b>		
Méretek	120 x 71 x 47 mm / 4,7 x 2,8 x 1,9 hüvelyk	129 x 71 x 47 mm / 5,1 x 2,8 x 1,9 hüvelyk
Súly	190 g/0,42 lb	205 g/0,45 lb

### Típek

Az üzemidő eredményei 25 °C-on/72 °F-en tesztelve RIX akkumulátorokkal.

Az akkumulátor élettartama a hőmérséklettől és a használati feltételektől függően változik.

# 04<sup>A</sup> DOBOZBAN

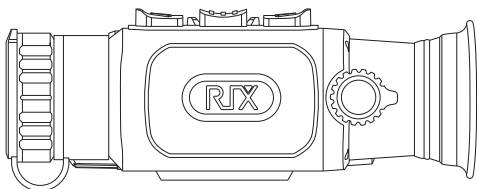

STRIDE sorozatú hőképkotó monokulár

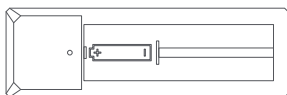

Akkumulátortöltő



USB C-típusú kábel



18650-es akkumulátor × 1  
(70 mm hosszú)

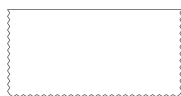

Lencsetörő-kendő

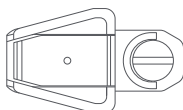

Adapter készlet × 2

(Ez a két adapterkészlet csak a meghatározott gyártási tételekkel kompatibilis.)

# 05 A TERMÉK MEGJELENÉSE



# 06 ESZKÖZMÓDOK

## Kézi mód

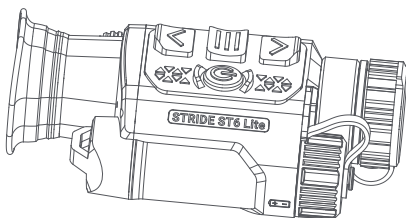

## Sisak mód

**1. mód:** A készülék két M5-ös furatának segítségével csatlakoztatható a tartókonzolhoz.

**1. lépés:** Csatlakoztassa az adapterkészletet a készülékhez.

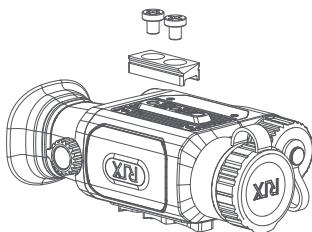
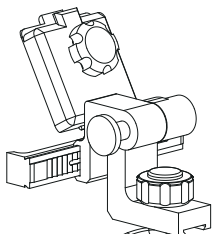

**2. lépés:**

Csatlakoztassa a sisakrögzítőt az adapterkészlethez.

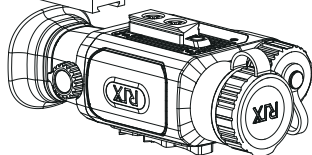

### 3. lépés:

Csatlakoztassa a sisakrögzítőt a sisakhoz.

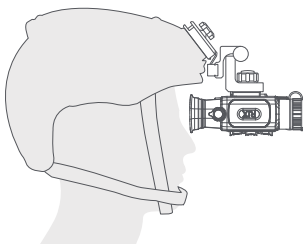

**2. mód:** A rögzítőkonzolhoz csatlakoztatható a készüléken lévő 1/4 hüvelykes furatok segítségével

**1. lépés:** Csatlakoztassa az adapterkészletet a készülékhez.

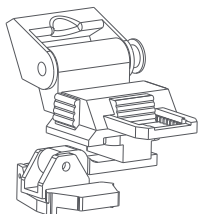
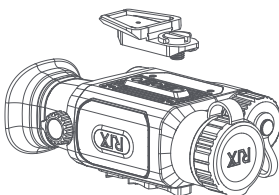

### 2. lépés:

Csatlakoztassa a sisakrögzítőt az adapterkészlethez.

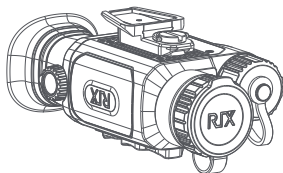

### 3. lépés:

Csatlakoztassa a sisakrögzítőt a sisakhoz.

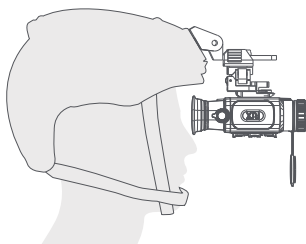

## 07 TÁPELLÁTÁS

A STRIDE ST3 Lite/ST6 Lite egy 18650-es cserélhető akkumulátorral működik (70 mm hosszú).

A C-típusú kábeles csatlakoztatás esetén táplálja a készüléket a folyamatosan működéshez, de nem tölti az akkumulátort.

- Forgassa el az akkumulátortartó rekesz fedelét, amíg le nem csavarja.
- Helyezze az akkumulátort a rekeszbe, a pozitív (+) pólus befelé, a negatív (-) pólus kifelé mutat, az akkumulátortartó rekesz külső részén lévő szimbólumoknak megfelelően
- Az akkumulátor behelyezését követően húzza meg az akkumulátortartó rekesz fedelét.

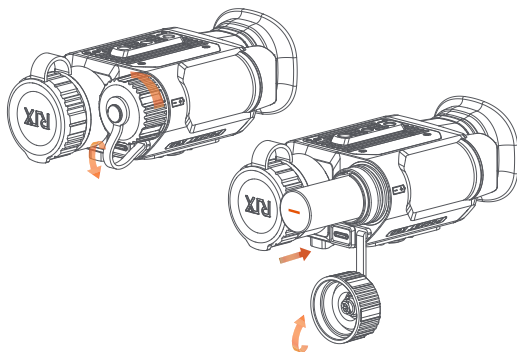

### FIGYELMEZTETÉS

- Kérjük, távolítsa el az akkumulátort, ha a készüléket hosszabb ideig nem használja.
- NE táplálja a készüléket módosított vagy sérült akkumulátorral.
- Ne használja az akkumulátort 122 °F feletti hőmérsékleten, mivel ez csökkentheti az akkumulátor élettartamát.

# 08 GOMBOK MŰKÖDÉSE

## Bekapcsolás/Kikapcsolás



### Nyomja meg és Tartsa

A készülék be- vagy kikapcsolása



### Lenyomás

Belépés készenléti állapotba/kilépés készenléti állapotból

## Kezdőképernyő



### Lenyomás

Digitális zoomra váltás



### Nyomja meg és Tartsa

Kép korrekciója



### Lenyomás

Kép mód váltása



### Nyomja meg és Tartsa

Belépés a beállítás menübe



### Lenyomás

Videófelvétel indítása/leállítása



### Nyomja meg és Tartsa

Fényképkészítés



## Főmenü képernyő



### Lenyomás

Görgetés felfelé



### Lenyomás

Visszatérés a kezdőképernyőre a módosítások mentésével



### Lenyomás

Görgetés lejjebb



### Lenyomás

A funkció paramétereinek beállítása

## 09 ÁLLAPOTSÁV

Az állapotsáv a képernyő alján található, és az eszköz üzemállapotára vonatkozó információkat jeleníti meg. Balról jobbra haladva:











1. Digitális zoom: 1×/1,5×/3×/6×
2. Időjárás mód: Nap/eső
3. EIS (Elektromos képstabilizálás): Be/ki
4. Automatikus képkorrekció mód: Be/ki
5. Wi-Fi-kapcsolat: Be/ki
6. Óra
7. Akkumulátorszint

# 10 FŐMENÜ

A Kezdőképernyőn nyomja meg és tartsa lenyomva a Menü gombot a Főmenü megnyitásához.

## Főmenü

	Képernyő fényereje
	Képkontraszt
	Automatikus készenlét
	Automatikus képkorrekció
	Elektromos képstabilizálás
	Időjárás mód
	Wi-Fi
	Információk
	Nyelvek

## 01 CARACTERÍSTICAS DO PRODUTO

- 2 em 1 multi-funções: Especificamente concebido para cenários de mão e de montagem no capacete
- Ampliação mínima de 1x, adequada para caminhar com montagem no capacete
- Resolução do sensor: ST3 Lite - 384×288/ST6 Lite - 640×512
- Ecrã de visualização: 1024×768
- Bateria substituível 18650 com um comprimento de 70 mm
- Design ergonómico, confortável de utilizar

## 02 DESCRIÇÃO DA APLICAÇÃO

Para obter mais funcionalidades, utilize a aplicação RIX+.



Uma vez que este produto é um dispositivo eletrónico, recomenda-se que leia ou descarregue o manual mais recente no sítio eletrónico da RIX ou na aplicação RIX+ para obter as instruções mais atualizadas do produto.

## 03 DESCRIÇÃO DO PRODUTO

Série	STRIDE	STRIDE
Produto	ST3 Lite	ST6 Lite
<b>Sensor</b>		
Resolução	384 x 288	640 x 512
Espaçamento de píxel	12 µm	
NETD	< 20 mK	
Taxa de quadros	50 Hz	
<b>Ótica</b>		
Lente objetiva	15 mm, F1,0	25 mm, F1,0
Ampliação	1x a 6x	
Campo de visão (HxV)	17,5° x 13,1°	
Zoom digital	1x / 2x / 4x	
Alívio dos Olhos	20 mm	
Ajuste da dioptria	-5D a +5D	
Alcance de Detecção	780 m / 852 yd	1300 m / 1423 yd
<b>Ecrã</b>		
Tipo	OLED	
Resolução	1024 x 768	
<b>Gravador de Vídeo</b>		
Resolução de vídeo/fotografia	1024 x 768	
Formato de vídeo/fotografia	.mp4 / .jpg	
Memória incorporada	32 GB	
<b>Caraterísticas Ambientais</b>		
Grau de Proteção, código IP	IP67	
Faixa de temperatura de operação	-20 °C a +50 °C / -4 °F a 122 °F	

Série	STRIDE	STRIDE
Produto	ST3 Lite	ST6 Lite
<b>Ligações e Compatibilidades</b>		
Tipo de bateria	18650 (comprimento de 70mm)	
Wi-Fi	Suporte	
Tempo de operação da bateria (a t=25 °C/72 °F)	4 h	
Fonte de Alimentação Externa	5 V (USB Tipo C)	
<b>Peso &amp; Tamanho</b>		
Dimensões	120 × 71 × 47 mm / 4,7 × 2,8 × 1,9 polegadas	129 × 71 × 47 mm / 5,1 × 2,8 × 1,9 polegadas
Peso	190 g / 0,42 lb	205 g / 0,45 lb

### Dicas

Os resultados do tempo de funcionamento são testados a 25 °C/72 °F utilizando baterias RIX. A duração da bateria pode variar consoante a temperatura e as condições de utilização.

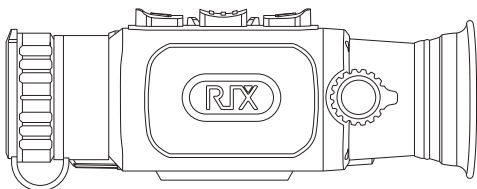

Monocular de Imagem Térmica da Série STRIDE

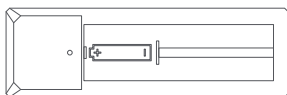

Carregador de Bateria



Cabo USB Tipo C



Bateria 18650 × 1  
(comprimento de 70 mm)



Pano para lente

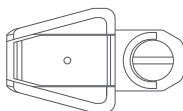

Kit de adaptador × 2

(Estes dois kits de adaptador são compatíveis apenas com os lotes de produção especificados.)

# 05 APARÊNCIA DO PRODUTO



## 06 MODOS DO DISPOSITIVO

### Modo de Mão

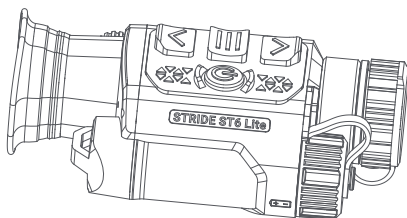

### Modo Capacete

**Modo 1:** Pode ser ligado ao suporte de montagem utilizando os dois orifícios M5 no dispositivo.

**Passo 1:** Fixe o kit de adaptador ao dispositivo.

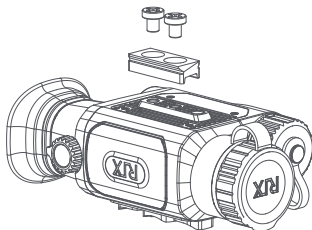
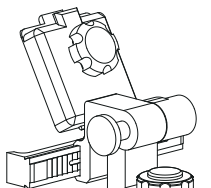

**Passo 2:**

Fixe o suporte do capacete ao kit de adaptador.

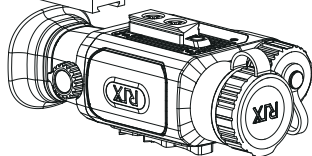

**Passo 3:**

Fixe o suporte do capacete ao capacete.

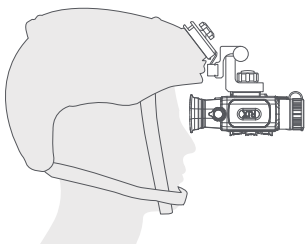

**Modo 2:** Pode ser ligado ao suporte de montagem utilizando os orifícios de 1/4 polegada no dispositivo.

**Passo 1:** Fixe o kit de adaptador ao dispositivo.

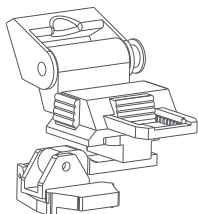
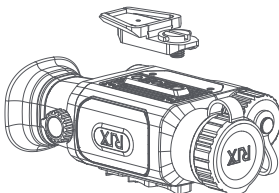

**Passo 2:**

Fixe o suporte do capacete ao kit de adaptador.

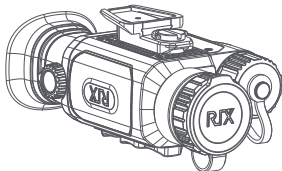

**Passo 3:**

Fixe o suporte do capacete ao capacete.

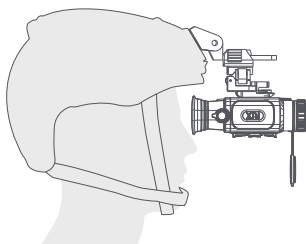

## 07 FONTE DE ALIMENTAÇÃO

O STRIDE ST3 Lite/ST6 Lite é equipado com uma bateria substituível 18650 (comprimento de 70mm).

Quando ligado através de Tipo C, alimenta o dispositivo para o manter em funcionamento, mas não carrega a bateria.

- Rode a tampa do compartimento da bateria até que ela seja desaparafusada.
- Instale a bateria no compartimento, com o polo positivo (+) para dentro e o polo negativo (-) para fora, conforme indicado pelos símbolos no exterior do compartimento da bateria.
- Depois de inserir a bateria, aperte a tampa do compartimento da bateria.

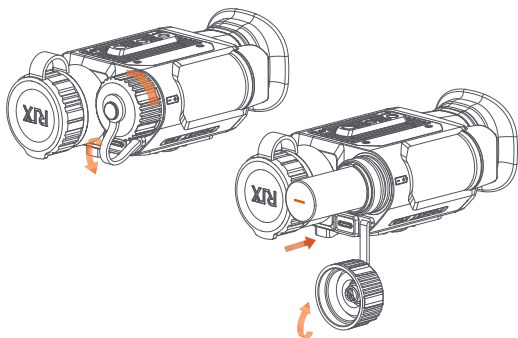

### ADVERTÊNCIA

- Remova a bateria se o dispositivo não for utilizado durante um longo período de tempo.
- NÃO utilize uma bateria modificada ou danificada para ligar o dispositivo.
- Não utilize a bateria a uma temperatura superior a 122 °F, pois pode reduzir a vida útil da bateria.

# 08 BOTÕES OPERAÇÃO

## Ligar/desligar



### Premir e Segurar

Ligar/desligar o dispositivo

## Em espera/Sair da espera



### Premir

Entrar/Sair da espera

## Ecrã Inicial



### Premir

Mudar o zoom digital



### Premir e Segurar

Correção de imagem



### Premir

Mudar o modo de imagem



### Premir e Segurar

Entrar no menu de definição



### Premir

Iniciar/Parar a gravação de vídeo



### Premir e Segurar

Tirar uma foto

## Ecrã do Menu Principal



### Premir

Rolar para cima



### Premir

Regressar ao ecrã inicial com as alterações guardadas



### Premir

Rolar para baixo



### Premir

Ajustar os parâmetros de uma função

## 09 BARRA DE ESTADO

A barra de estado está localizada na parte inferior do ecrã e apresenta as informações sobre o estado de funcionamento do dispositivo. Da esquerda para a direita:



1. Zoom digital: 1×/1,5×/3×/6×
2. Modo meteorológico: Sol/Chuva
3. EIS (Estabilização eletrónica de imagem): Ligado/Desligado
4. Modo de correção automática de imagem: Ligado/Desligado
5. Ligação Wi-Fi: Ligado/Desligado
6. Relógio
7. Nível da bateria

# 10 MENU PRINCIPAL

No ecrã inicial, prima e segure o botão Menu para abrir o menu principal.

## Menu Principal



Brilho de Ecrã



Contraste da Imagem



Espera Automática



Correção Automática de Imagem



Estabilização Elétrica de Imagem



Modo Meteorológico



Wi-Fi



Informações



Idiomas

## Environmental influences

Never point the lens of the device directly at intense heat sources such as the sun or laser equipment. The objective lens and eyepiece can function as a burning glass and damage the interior components.

## Risk of swallowing

Do not place this device in the hands of small children. Incorrect handling can cause small parts to come loose which may be swallowed.

## Safety instructions for use

- Handle the device with care: rough handling may damage the battery.
- Do not expose the device to fire or high temperatures.
- Install the batteries correctly according to the instruction on the device. Reverse connection is prohibited.
- The battery capacity decreases when operated in a cold ambient temperature. This is not a fault and occurs for technical reasons.
- Always store the device in a dry, well-ventilated space. For prolonged storage, remove the batteries.
- The recommended temperature for using this product is -20°C to +50°C. Otherwise, it will affect the service life of the product.
- Do not store the device for long periods at temperatures below 20°C or above 50°C, or this will permanently reduce the capacity of the battery.
- If the device has been damaged or the battery is defective, send the device to our after-sales service for repair.

## Wireless Transmitter Module Frequency Range

WLAN: 2.412-2.472GHz

Wireless transmitter module power < 20dBm



We, Visir Inc. hereby declares that the radio equipment types STRIDE series are in compliance with the Directives 2014/53/EU and 2011/65/EU.

## Disposal of batteries

2023/1542 (Battery Regulation): This product contains a battery that cannot be disposed of as unsorted municipal waste in the European Union. See the product documentation for specific battery information. The battery is



marked with this symbol, which may include lettering to indicate cadmium (Cd), lead (Pb), or mercury (Hg). For proper recycling, return the battery to your supplier or to a designated collection point. For more information see: [www.recyclethis.info](http://www.recyclethis.info)

### **User information on the disposal of electrical and electronic devices (private households)**



2012/19/EU (WEEE directive): Products marked with this symbol cannot be disposed of as unsorted municipal waste in the European Union. For proper recycling, return this product to your local supplier upon the purchase of equivalent new equipment, or dispose of it at designated collection points. For more information see: [www.recyclethis.info](http://www.recyclethis.info)

### **Installing/Removing the battery**

The STRIDE series uses a replaceable 18650 battery with a length of 70mm. Please refer to the section of “Battery Install” section for instructions on replacing the 18650 battery.

### **FCC Statement**

FCC ID: 2A7ZZ-STRD-00

### **Labeling Requirements**

This device complies with part 15 of the FCC Rules. Operation is subject to the following two conditions: (1) This device may not cause harmful interference, and (2) this device must accept any interference received, including interference that may cause undesired operation.

### **Information To The User**

Any Changes or modifications not expressly approved by the party responsible for compliance could void the user's authority to operate the equipment.

### **EMC Class B**

This equipment has been tested and found to comply with the limits for a Class B digital device, pursuant to part 15 of the FCC Rules. These limits are designed to provide reasonable protection against harmful interference in a residential installation. This equipment generates, uses and can radiate radio frequency

energy and, if not installed and used in accordance with the instructions, may cause harmful interference to radio communications. However, there is no

guarantee that interference will not occur in a particular installation. If this equipment does cause harmful interference to radio or television reception, which can be determined by turning the equipment off and on, the user is encouraged to try to correct the interference by one or more of the following measures:

- Reorient or relocate the receiving antenna.
- Increase the separation between the equipment and receiver.
- Connect the equipment into an outlet on a circuit different from that to which the receiver is connected.
- Consult the dealer or an experienced radio/TV technician for help.

The device has been evaluated to meet general RF exposure requirement.

The device can be used in portable exposure condition without restriction.

## ⚠ WARNING

- **INGESTION HAZARD:** This product contains a button cell or coin battery.
- **DEATH** or serious injury can occur if ingested.
- A swallowed button cell or coin battery can cause **Internal Chemical Burns** in as little as **2 hours**.
- **KEEP** new and used batteries **OUT OF REACH OF CHILDREN**
- **Seek immediate medical attention** if a battery is suspected to be swallowed or inserted inside any part of the body.



- Remove and immediately recycle or dispose of used batteries according to local regulations and keep away from children. Do NOT dispose of batteries in household trash or incinerate.
- Even used batteries may cause severe injury or death.
- Call a local poison control center for treatment information.
- Battery type: ML1220
- Nominal voltage: 3V
- Non-rechargeable batteries are not to be recharged.
- Do not force discharge, recharge, disassemble, heat above (manufacturer's specified temperature rating) or incinerate. Doing so may result in injury due to venting, leakage or explosion resulting in chemical burns.
- The product contains a non-replaceable battery.







**Tel:** +1 (800) 580-5281

**Web:** [www.rixoptics.com](http://www.rixoptics.com)

**Email:** [support@rix-nv.com](mailto:support@rix-nv.com)

**Addr.:** 700 International Pkwy Ste 102, Richardson TX 75081